

**ENGINEERING REPORT**

**FOR**

**L30×45 WAREHOUSE**

**TENT**

# Contents

<b>1</b>	<b>PRELIMINAR .....</b>	<b>1</b>
<b>2</b>	<b>STANDARDS .....</b>	<b>1</b>
<b>3</b>	<b>GEOMETRIES .....</b>	<b>1</b>
<b>4</b>	<b>MATERIAL .....</b>	<b>2</b>
<b>5</b>	<b>LOAD CASES AND LOAD COMBINATIONS.....</b>	<b>18</b>
5.1	Load .....	18
5.2	Pressure coefficients( $C_{fig}$ ) .....	19
5.3	Pressure forces (F) .....	19
5.4	Load diagram .....	20
5.5	Load combination .....	20
<b>6</b>	<b>CALCULATION RESULTS .....</b>	<b>21</b>
6.1	Calculation result of combination displacement .....	21
6.2	Results of internal force with enclosure .....	23
<b>7</b>	<b>SUMMARY RESULTS.....</b>	<b>24</b>
7.1	Intensity.....	25
7.2	Stability of 2 axis .....	25
7.3	Stability of 3 axis .....	26
7.4	Total Design calculation results table.....	26
<b>8</b>	<b>CONCLIUSION .....</b>	<b>40</b>

# 1 PRELIMINAR

This report examines the effect of wind loads on the temporary structure of which is L30x45. The appropriate wind load is provided by the client and determined in accordance with AS-NZS 1170.2. The design wind speed and appropriate parameters such as wind action, terrain/height, shielding, topography and aerodynamic shape of structure are considered and reflected in the final design wind load on the structure.

Under the design wind load, serviceability and ultimate capacity of the structure are checked to ensure the structure is adequate without imposing any danger or hazard to the user and the surroundings. Hence, factor of safety and appropriate load combinations, as stated in AS-NZS1170, are used to check the ultimate capacity of the members.

Computer 3D modeling and analysis program such as 3D3S is employed to perform the analysis on the structure.

## 2 STANDARDS

The standards used are listed here.

- GB/T 6892-2015 Wrought aluminium and aluminium alloys extruded profiles for general engineering.
- GB/T 700-2006 Carbon structural steels
- AS/NZS 1664.1: 1997 Aluminium Structures Part1 : Limit state design
- AS/NZS 1170.0: 2002 Structure design actions Part 0: General principles
- AS/NZS 1170.1: 2002 Structure design actions Part 1: Permanent, imposed and other actions
- AS/NZS 1170.2: 2002 Structure design actions Part 2: Wind actions
- AS 4100: 1998 Steel structures
- AS/NZS 1554.1: 2004 Structural steel welding- Welding of steel structures

## 3 GEOMETRIES

Here it concerns an aluminium structure, including column, roof beams, gable wall, roof purlin and tarpaulins. The following Figure 1 present the structure. The number are the node code, and the circles represent the supporting base. The following Figure 2 present the elements number of this structure.

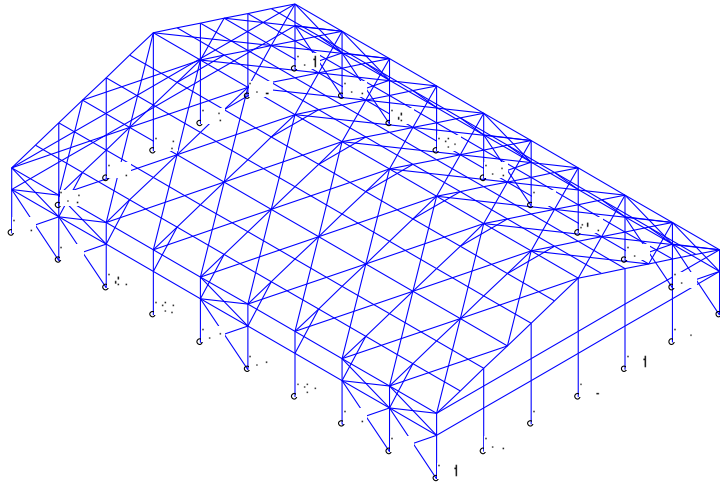

Figure 1 Simplified Computational Mode

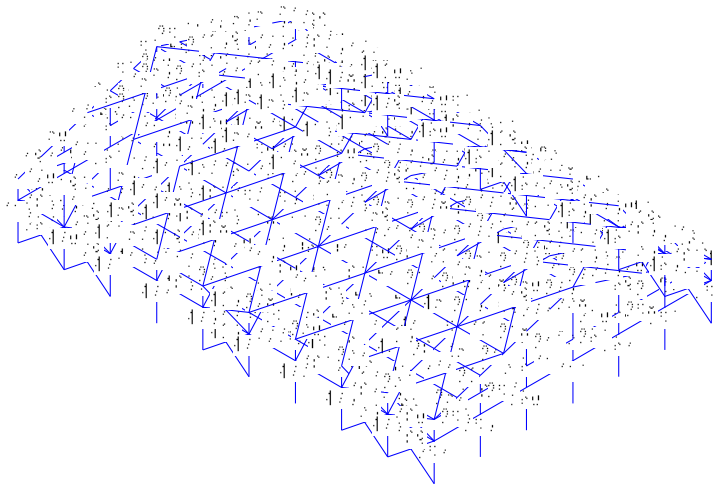

Figure 2 Elements information

The structure size is 30m (span or width) \* 45m (length) \* 6m (eave height), while the ridge height is 10.874m, the distance between the adjacent bays is 5m.

## 4 MATERIAL

The structural material are listed in the following Table 1 and Table 2.

Table 1 Material property of Aluminium

<b>Aluminium alloy 6061-T6 GB/T 6892-2006</b>	
Young's Modulus E	70000MPa
Shear modulus G	27000MPa
Poisson's Ration v	0.3
Density	2700kg/m <sup>3</sup>

Proof strength ( $f_{0.2}$ )	240MPa
Ultimate Strength ( $f_u$ )	260MPa

Table 2 Material property of Steel Q235B

<b>Steel Q235B / GB/T 700-2006</b>	
Young's Modulus E	206000MPa
Poisson's Ration $\nu$	0.3
Density	7850kg/m <sup>3</sup>
Partial Safety Factor ( $\gamma_M$ )	1.0
Yield Strength ( $f_{y1}$ )	235MPa( $t \leq 16$ mm)
Ultimate Tensile Strength ( $f_u$ )	370MPa ( $t \leq 100$ mm)

The element sections are listed in the following Table 3.

Table 3 Element Sections diagram

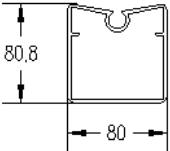
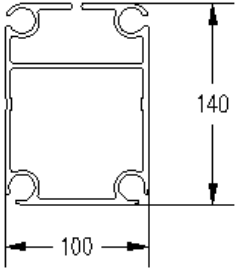
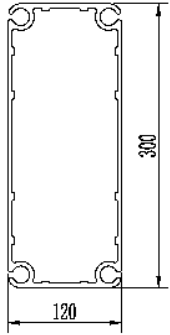
Section No.	Profile	Material	Area(mm <sup>2</sup> )	I <sub>x</sub> (mm <sup>4</sup> )	I <sub>y</sub> (mm <sup>4</sup> )	Section Modulus Z <sub>x</sub> (mm <sup>3</sup> )	Section Modulus Z <sub>y</sub> (mm <sup>3</sup> )	Radius of Gyration r <sub>x</sub> (mm)	Radius of Gyration r <sub>y</sub> (mm)
1		6061-T6	952.055	8.2E5	8.7E5	19614.9	21716	29.3394	30.2057
2		6061-T6	2330.38	5.6E6	3.3E6	77510.6	66558.3	49.0919	37.8538
3		6061-T6	4861.37	5.89E7	1.19E7	386097	199952	109.148	49.6774

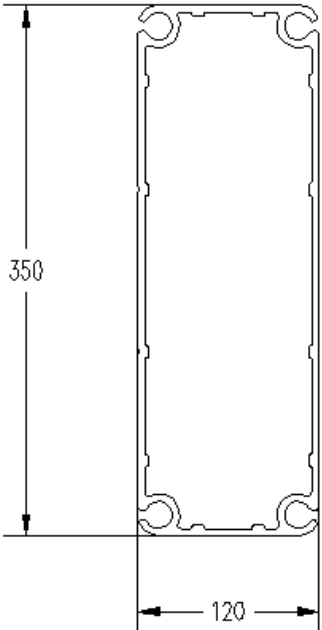
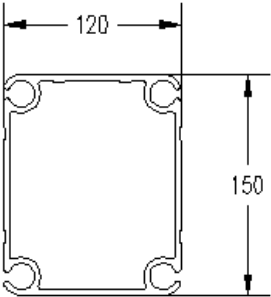
4		6061-T6	5361.25	8.5E7	1.4E7	484903	227517	125.81	50.4603
5		6061-T6	2550.5	8.5E6	5.5E6	113415	91358.7	57.7501	46.3594
6	Tube 60*60*3	Q235	554.613	3.0E5	3.0E5	9984.57	9984.57	23.2397	23.2397
7	Wire rope (φ12)	-	113	-	-	-	-	-	-

As is shown in Table 4, the detail information such as section number, length have been listed.

Table 4 Elements information

Element No.	Section No.	Length(m)	I node release	J node release
1	4	2.000	---	---
2	2	5.000	R2 R3	R2 R3
3	2	5.000	R2 R3	R2 R3
4	4	2.000	---	---
5	4	2.629	---	---
6	4	2.000	---	---
7	4	2.629	---	---
8	3	2.000	---	---
9	3	1.625	---	R2 R3
10	3	2.000	---	---
11	3	1.625	---	R2 R3
12	2	5.000	R2 R3	R2 R3
13	2	5.000	R2 R3	R2 R3
14	4	2.000	---	---
15	4	2.629	---	---
16	4	2.629	---	---
17	4	2.629	---	---
18	4	2.000	---	---
19	4	2.629	---	---
20	4	2.629	---	---
21	4	2.629	---	---
22	4	2.000	---	---
23	4	2.629	---	---
24	4	2.629	---	---
25	4	2.629	---	---
26	4	2.629	---	---
27	4	2.629	---	---
28	4	2.629	---	---
29	4	2.629	---	---
30	4	2.629	---	---
31	2	5.000	R2 R3	R2 R3
32	2	5.000	R2 R3	R2 R3
33	2	5.000	R2 R3	R2 R3
34	1	5.000	R2 R3	R2 R3
35	1	5.000	R2 R3	R2 R3
36	1	5.000	R2 R3	R2 R3



Element No.	Section No.	Length(m)	I node release	J node release
37	1	5.000	R2 R3	R2 R3
38	1	5.000	R2 R3	R2 R3
39	1	5.000	R2 R3	R2 R3
40	2	5.000	R2 R3	R2 R3
41	2	5.000	R2 R3	R2 R3
42	2	5.000	R2 R3	R2 R3
43	1	5.000	R2 R3	R2 R3
44	1	5.000	R2 R3	R2 R3
45	1	5.000	R2 R3	R2 R3
46	1	5.000	R2 R3	R2 R3
47	1	5.000	R2 R3	R2 R3
48	1	5.000	R2 R3	R2 R3
49	2	5.000	R2 R3	R2 R3
50	2	5.000	R2 R3	R2 R3
51	2	5.000	R2 R3	R2 R3
52	1	5.000	R2 R3	R2 R3
53	1	5.000	R2 R3	R2 R3
54	1	5.000	R2 R3	R2 R3
55	1	5.000	R2 R3	R2 R3
56	1	5.000	R2 R3	R2 R3
57	1	5.000	R2 R3	R2 R3
58	2	5.000	R2 R3	R2 R3
59	2	5.000	R2 R3	R2 R3
60	2	5.000	R2 R3	R2 R3
61	1	5.000	R2 R3	R2 R3
62	1	5.000	R2 R3	R2 R3
63	1	5.000	R2 R3	R2 R3
64	1	5.000	R2 R3	R2 R3
65	1	5.000	R2 R3	R2 R3
66	1	5.000	R2 R3	R2 R3
67	7	5.385	R1 R2 R3	R2 R3
68	7	5.385	R1 R2 R3	R2 R3
69	7	5.385	R1 R2 R3	R2 R3
70	7	5.385	R1 R2 R3	R2 R3
71	7	9.337	R1 R2 R3	R2 R3
72	7	9.337	R1 R2 R3	R2 R3
73	7	9.337	R1 R2 R3	R2 R3
74	7	9.337	R1 R2 R3	R2 R3
75	7	9.337	R1 R2 R3	R2 R3
76	7	9.337	R1 R2 R3	R2 R3

Element No.	Section No.	Length(m)	I node release	J node release
77	7	9.337	R1 R2 R3	R2 R3
78	7	9.337	R1 R2 R3	R2 R3
79	7	5.385	R1 R2 R3	R2 R3
80	7	5.385	R1 R2 R3	R2 R3
81	7	5.385	R1 R2 R3	R2 R3
82	7	5.385	R1 R2 R3	R2 R3
83	2	5.000	R2 R3	R2 R3
84	2	5.000	R2 R3	R2 R3
85	2	5.000	R2 R3	R2 R3
86	2	5.000	R2 R3	R2 R3
87	2	5.000	R2 R3	R2 R3
88	2	5.000	R2 R3	R2 R3
89	2	5.000	R2 R3	R2 R3
90	4	2.629	---	---
91	4	2.629	---	---
92	1	5.000	R2 R3	R2 R3
93	1	5.000	R2 R3	R2 R3
94	1	5.000	R2 R3	R2 R3
95	1	5.000	R2 R3	R2 R3
96	1	5.000	R2 R3	R2 R3
97	1	5.000	R2 R3	R2 R3
98	4	2.629	---	---
99	4	2.629	---	---
100	4	2.629	---	---
101	4	2.629	---	---
102	4	2.629	---	---
103	4	2.629	---	---
104	4	2.629	---	---
105	4	2.629	---	---
106	4	2.629	---	---
107	4	2.629	---	---
108	4	2.629	---	---
109	4	2.629	---	---
110	4	2.000	---	---
111	2	5.000	R2 R3	R2 R3
112	1	5.000	R2 R3	R2 R3
113	1	5.000	R2 R3	R2 R3
114	1	5.000	R2 R3	R2 R3
115	1	5.000	R2 R3	R2 R3
116	1	5.000	R2 R3	R2 R3

Element No.	Section No.	Length(m)	I node release	J node release
117	1	5.000	R2 R3	R2 R3
118	4	2.629	---	---
119	4	2.629	---	---
120	4	2.629	---	---
121	4	2.629	---	---
122	4	2.000	---	---
123	4	2.629	---	---
124	4	2.000	---	---
125	2	5.000	R2 R3	R2 R3
126	1	5.000	R2 R3	R2 R3
127	1	5.000	R2 R3	R2 R3
128	1	5.000	R2 R3	R2 R3
129	1	5.000	R2 R3	R2 R3
130	1	5.000	R2 R3	R2 R3
131	1	5.000	R2 R3	R2 R3
132	4	2.629	---	---
133	4	2.629	---	---
134	4	2.629	---	---
135	4	2.000	---	---
136	4	2.629	---	---
137	4	2.000	---	---
138	3	2.000	---	---
139	3	1.625	---	R2 R3
140	3	2.000	---	---
141	3	1.625	---	R2 R3
142	2	5.000	R2 R3	R2 R3
143	2	5.000	R2 R3	R2 R3
144	2	5.000	R2 R3	R2 R3
145	2	5.000	R2 R3	R2 R3
146	4	2.000	---	---
147	4	2.629	---	---
148	4	2.629	---	---
149	4	2.629	---	---
150	4	2.629	---	---
151	4	2.629	---	---
152	4	2.629	---	---
153	4	2.629	---	---
154	7	9.337	R1 R2 R3	R2 R3
155	7	9.337	R1 R2 R3	R2 R3
156	7	9.337	R1 R2 R3	R2 R3

Element No.	Section No.	Length(m)	I node release	J node release
157	7	9.337	R1 R2 R3	R2 R3
158	7	5.385	R1 R2 R3	R2 R3
159	7	5.385	R1 R2 R3	R2 R3
160	7	5.385	R1 R2 R3	R2 R3
161	7	5.385	R1 R2 R3	R2 R3
162	7	9.337	R1 R2 R3	R2 R3
163	7	9.337	R1 R2 R3	R2 R3
164	7	9.337	R1 R2 R3	R2 R3
165	7	9.337	R1 R2 R3	R2 R3
166	7	5.385	R1 R2 R3	R2 R3
167	7	5.385	R1 R2 R3	R2 R3
168	7	5.385	R1 R2 R3	R2 R3
169	7	5.385	R1 R2 R3	R2 R3
170	4	2.629	---	---
171	4	2.629	---	---
172	4	2.000	---	---
173	4	2.000	---	---
174	4	2.629	---	---
175	4	2.629	---	---
176	4	2.000	---	---
177	4	2.000	---	---
178	4	2.629	---	---
179	4	2.629	---	---
180	4	2.629	---	---
181	4	2.629	---	---
182	3	2.000	---	---
183	3	3.249	---	R2 R3
184	3	2.000	---	---
185	3	3.249	---	R2 R3
186	3	2.000	---	---
187	3	3.249	---	R2 R3
188	3	2.000	---	---
189	3	3.249	---	R2 R3
190	4	2.629	---	---
191	4	2.629	---	---
192	4	2.629	---	---
193	4	2.629	---	---
194	4	2.629	---	---
195	4	2.629	---	---
196	1	5.000	R2 R3	R2 R3

Element No.	Section No.	Length(m)	I node release	J node release
197	1	5.000	R2 R3	R2 R3
198	1	5.000	R2 R3	R2 R3
199	1	5.000	R2 R3	R2 R3
200	1	5.000	R2 R3	R2 R3
201	1	5.000	R2 R3	R2 R3
202	1	5.000	R2 R3	R2 R3
203	1	5.000	R2 R3	R2 R3
204	1	5.000	R2 R3	R2 R3
205	1	5.000	R2 R3	R2 R3
206	1	5.000	R2 R3	R2 R3
207	1	5.000	R2 R3	R2 R3
208	1	5.000	R2 R3	R2 R3
209	1	5.000	R2 R3	R2 R3
210	2	5.000	R2 R3	R2 R3
211	2	5.000	R2 R3	R2 R3
212	4	2.629	---	---
213	4	2.629	---	---
214	4	2.629	---	---
215	4	2.629	---	---
216	4	2.629	---	---
217	4	2.629	---	---
218	4	2.629	---	---
219	4	2.629	---	---
220	4	2.629	---	---
221	4	2.629	---	---
222	4	2.629	---	---
223	4	2.629	---	---
224	5	3.763	---	---
225	5	3.763	---	---
226	5	3.763	---	---
227	5	3.763	---	---
228	5	3.763	---	---
229	5	3.763	---	---
230	5	3.763	---	---
231	5	3.763	---	---
232	5	3.763	---	---
233	5	3.763	---	---
234	5	3.763	---	---
235	5	3.763	---	---
236	2	5.000	R2 R3	R2 R3

Element No.	Section No.	Length(m)	I node release	J node release
237	3	2.000	---	---
238	3	4.874	---	R2 R3
239	3	2.000	---	---
240	3	4.874	---	R2 R3
241	2	5.000	R2 R3	R2 R3
242	4	2.629	---	---
243	4	2.629	---	---
244	4	2.629	---	---
245	4	2.629	---	---
246	4	2.629	---	---
247	4	2.629	---	---
248	4	2.629	---	---
249	4	2.629	---	---
250	1	5.000	R2 R3	R2 R3
251	1	5.000	R2 R3	R2 R3
252	1	5.000	R2 R3	R2 R3
253	1	5.000	R2 R3	R2 R3
254	1	5.000	R2 R3	R2 R3
255	1	5.000	R2 R3	R2 R3
256	1	5.000	R2 R3	R2 R3
257	1	5.000	R2 R3	R2 R3
258	1	5.000	R2 R3	R2 R3
259	1	5.000	R2 R3	R2 R3
260	1	5.000	R2 R3	R2 R3
261	1	5.000	R2 R3	R2 R3
262	1	5.000	R2 R3	R2 R3
263	1	5.000	R2 R3	R2 R3
264	4	2.629	---	---
265	4	2.629	---	---
266	4	2.629	---	---
267	4	2.629	---	---
268	4	2.629	---	---
269	4	2.629	---	---
270	4	2.629	---	---
271	4	2.629	---	---
272	4	2.629	---	---
273	4	2.629	---	---
274	4	2.629	---	---
275	4	2.629	---	---
276	4	2.629	---	---

Element No.	Section No.	Length(m)	I node release	J node release
277	4	2.629	---	---
278	4	2.629	---	---
279	4	2.629	---	---
280	3	4.000	---	---
281	3	4.000	---	---
282	3	4.000	---	---
283	3	4.000	---	---
284	2	5.000	R2 R3	R2 R3
285	2	5.000	R2 R3	R2 R3
286	6	6.403	R2 R3	R2 R3
287	6	6.403	R2 R3	R2 R3
288	6	6.403	R2 R3	R2 R3
289	6	6.403	R2 R3	R2 R3
290	2	5.000	R2 R3	R2 R3
291	2	5.000	R2 R3	R2 R3
292	4	4.000	---	---
293	4	4.000	---	---
294	3	4.000	---	---
295	3	4.000	---	---
296	2	5.000	R2 R3	R2 R3
297	2	5.000	R2 R3	R2 R3
298	2	5.000	R2 R3	R2 R3
299	2	5.000	R2 R3	R2 R3
300	2	5.000	R2 R3	R2 R3
301	2	5.000	R2 R3	R2 R3
302	2	5.000	R2 R3	R2 R3
303	2	5.000	R2 R3	R2 R3
304	2	5.000	R2 R3	R2 R3
305	2	5.000	R2 R3	R2 R3
306	2	5.000	R2 R3	R2 R3
307	2	5.000	R2 R3	R2 R3
308	6	6.403	R2 R3	R2 R3
309	6	6.403	R2 R3	R2 R3
310	6	6.403	R2 R3	R2 R3
311	6	6.403	R2 R3	R2 R3
312	2	5.000	R2 R3	R2 R3
313	2	5.000	R2 R3	R2 R3
314	3	4.000	---	---
315	3	4.000	---	---
316	4	4.000	---	---

Element No.	Section No.	Length(m)	I node release	J node release
317	4	4.000	---	---
318	3	4.000	---	---
319	3	4.000	---	---
320	2	5.000	R2 R3	R2 R3
321	2	5.000	R2 R3	R2 R3
322	2	5.000	R2 R3	R2 R3
323	2	5.000	R2 R3	R2 R3
324	2	5.000	R2 R3	R2 R3
325	2	5.000	R2 R3	R2 R3
326	2	5.000	R2 R3	R2 R3
327	2	5.000	R2 R3	R2 R3
328	6	6.403	R2 R3	R2 R3
329	6	6.403	R2 R3	R2 R3
330	6	6.403	R2 R3	R2 R3
331	6	6.403	R2 R3	R2 R3
332	6	6.403	R2 R3	R2 R3
333	6	6.403	R2 R3	R2 R3
334	6	6.403	R2 R3	R2 R3
335	6	6.403	R2 R3	R2 R3
336	7	9.337	R1 R2 R3	R2 R3
337	7	9.337	R1 R2 R3	R2 R3
338	7	9.337	R1 R2 R3	R2 R3
339	7	9.337	R1 R2 R3	R2 R3
340	7	9.337	R1 R2 R3	R2 R3
341	7	9.337	R1 R2 R3	R2 R3
342	7	9.337	R1 R2 R3	R2 R3
343	7	9.337	R1 R2 R3	R2 R3
344	7	9.337	R1 R2 R3	R2 R3
345	7	9.337	R1 R2 R3	R2 R3
346	7	9.337	R1 R2 R3	R2 R3
347	7	9.337	R1 R2 R3	R2 R3
348	7	9.337	R1 R2 R3	R2 R3
349	7	9.337	R1 R2 R3	R2 R3
350	7	9.337	R1 R2 R3	R2 R3
351	7	9.337	R1 R2 R3	R2 R3
352	7	9.337	R1 R2 R3	R2 R3
353	7	9.337	R1 R2 R3	R2 R3
354	7	9.337	R1 R2 R3	R2 R3
355	7	9.337	R1 R2 R3	R2 R3
356	7	9.337	R1 R2 R3	R2 R3



Element No.	Section No.	Length(m)	I node release	J node release
357	7	9.337	R1 R2 R3	R2 R3
358	7	9.337	R1 R2 R3	R2 R3
359	7	9.337	R1 R2 R3	R2 R3
360	7	9.337	R1 R2 R3	R2 R3
361	7	9.337	R1 R2 R3	R2 R3
362	7	9.337	R1 R2 R3	R2 R3
363	7	9.337	R1 R2 R3	R2 R3
364	7	9.337	R1 R2 R3	R2 R3
365	7	9.337	R1 R2 R3	R2 R3
366	7	9.337	R1 R2 R3	R2 R3
367	7	9.337	R1 R2 R3	R2 R3
368	7	9.337	R1 R2 R3	R2 R3
369	7	9.337	R1 R2 R3	R2 R3
370	7	9.337	R1 R2 R3	R2 R3
371	7	9.337	R1 R2 R3	R2 R3
372	7	9.337	R1 R2 R3	R2 R3
373	7	9.337	R1 R2 R3	R2 R3
374	7	9.337	R1 R2 R3	R2 R3
375	7	9.337	R1 R2 R3	R2 R3
376	5	5.000	---	---
377	5	5.000	---	---
378	5	5.000	---	---
379	5	5.000	---	---
380	5	5.000	---	---
381	5	5.000	---	---
382	1	5.000	R2 R3	R2 R3
383	1	5.000	R2 R3	R2 R3
384	4	2.629	---	---
385	4	2.629	---	---
386	5	3.763	---	---
387	5	3.763	---	---
388	1	5.000	R2 R3	R2 R3
389	1	5.000	R2 R3	R2 R3
390	4	2.629	---	---
391	4	2.629	---	---
392	4	2.629	---	---
393	4	2.629	---	---
394	2	5.000	R2 R3	R2 R3
395	1	5.000	R2 R3	R2 R3
396	1	5.000	R2 R3	R2 R3

Element No.	Section No.	Length(m)	I node release	J node release
397	1	5.000	R2 R3	R2 R3
398	1	5.000	R2 R3	R2 R3
399	1	5.000	R2 R3	R2 R3
400	1	5.000	R2 R3	R2 R3
401	4	2.629	---	---
402	4	2.629	---	---
403	4	2.629	---	---
404	4	2.629	---	---
405	2	5.000	R2 R3	R2 R3
406	2	5.000	R2 R3	R2 R3
407	7	9.337	R1 R2 R3	R2 R3
408	7	9.337	R1 R2 R3	R2 R3
409	7	9.337	R1 R2 R3	R2 R3
410	7	9.337	R1 R2 R3	R2 R3
411	7	9.337	R1 R2 R3	R2 R3
412	7	9.337	R1 R2 R3	R2 R3
413	7	9.337	R1 R2 R3	R2 R3
414	7	9.337	R1 R2 R3	R2 R3
415	5	5.000	---	---
416	2	5.000	R2 R3	R2 R3
417	2	5.000	R2 R3	R2 R3
418	4	2.629	---	---
419	4	2.629	---	---
420	4	2.000	---	---
421	4	2.000	---	---
422	1	5.000	R2 R3	R2 R3
423	1	5.000	R2 R3	R2 R3
424	4	2.629	---	---
425	4	2.629	---	---
426	5	3.763	---	---
427	5	3.763	---	---
428	1	5.000	R2 R3	R2 R3
429	1	5.000	R2 R3	R2 R3
430	4	2.629	---	---
431	4	2.629	---	---
432	4	2.629	---	---
433	4	2.629	---	---
434	2	5.000	R2 R3	R2 R3
435	1	5.000	R2 R3	R2 R3
436	1	5.000	R2 R3	R2 R3

Element No.	Section No.	Length(m)	I node release	J node release
437	1	5.000	R2 R3	R2 R3
438	1	5.000	R2 R3	R2 R3
439	1	5.000	R2 R3	R2 R3
440	1	5.000	R2 R3	R2 R3
441	4	2.629	---	---
442	4	2.629	---	---
443	4	2.629	---	---
444	4	2.629	---	---
445	2	5.000	R2 R3	R2 R3
446	2	5.000	R2 R3	R2 R3
447	7	9.337	R1 R2 R3	R2 R3
448	7	9.337	R1 R2 R3	R2 R3
449	7	9.337	R1 R2 R3	R2 R3
450	7	9.337	R1 R2 R3	R2 R3
451	7	9.337	R1 R2 R3	R2 R3
452	7	9.337	R1 R2 R3	R2 R3
453	7	9.337	R1 R2 R3	R2 R3
454	7	9.337	R1 R2 R3	R2 R3
455	5	5.000	---	---
456	2	5.000	R2 R3	R2 R3
457	2	5.000	R2 R3	R2 R3
458	4	2.629	---	---
459	4	2.629	---	---
460	4	2.000	---	---
461	4	2.000	---	---
462	6	6.403	R2 R3	R2 R3
463	6	6.403	R2 R3	R2 R3
464	7	5.385	R1 R2 R3	R2 R3
465	7	5.385	R1 R2 R3	R2 R3
466	6	6.403	R2 R3	R2 R3
467	6	6.403	R2 R3	R2 R3
468	7	5.385	R1 R2 R3	R2 R3
469	7	5.385	R1 R2 R3	R2 R3
470	4	4.000	---	---
471	4	4.000	---	---
472	4	4.000	---	---
473	4	4.000	---	---
474	4	4.000	---	---
475	4	4.000	---	---
476	4	4.000	---	---

Element No.	Section No.	Length(m)	I node release	J node release
477	4	4.000	---	---
478	4	4.000	---	---
479	4	4.000	---	---
480	4	4.000	---	---
481	4	4.000	---	---
482	4	4.000	---	---
483	4	4.000	---	---
484	4	4.000	---	---
485	4	4.000	---	---

## 5 LOAD CASES AND LOAD COMBINATIONS

### 5.1 Load

As per design consideration, the following individual loads were taken into account. The tent is used as a warehouse, the importance level for this structure is **2**. (AS/NZS 1170.0 Table 3.3)

- G: Dead Load, including self-weight of structure, connection parts, decoration material, and so on; (AS/NZS 1170.1 Appendix A)
  - The self-weight of structure was calculated by the program automatically;
  - The tarpaulin is weight 850g/m<sup>2</sup>, take 0.01KN/m<sup>2</sup> as the dead loads into account for safety reason
- W<sub>U</sub>: Wind actions, the V<sub>R</sub> is provided by the client as **45m/s**, the terrain is considered as category **2.5**;
- $V_{sit,\beta} = V_R M_d (M_{z,cat} M_s M_t)$  (AS/NZS 1170.2 Section 2.2)

where:

$$V_R = 45\text{m/s}; \quad \text{Provided by client}$$

$$M_d = \max \{M_d (N;NE;E;SE;S;SW;W;NW)\} = 1 \quad (\text{AS/NZS 1170.2 Table3.2})$$

$$M_{z,cat} = 0.87 \quad (\text{intermediate value of AS/NZS 1170.2 Table4.1(A)})$$

$$M_s = 1.0 \quad (\text{intermediate value of AS/NZS 1170.2 Table4.3})$$

$$M_t = 1 \quad (\text{AS/NZS 1170.2 Section 4.4.1})$$

$$V_{sit,\beta} = 45 \times 1 (1 \times 0.87 \times 1.0 \times 1) = 39.15$$

- $V_{des} = \max \{ V_{sit,\beta} \} = 39.15\text{m/s}$  (equal to 140km/h)
- $p = (0.5\rho_{air}) [ V_{des} ]^2 C_{fig} C_{dyn}$  (AS/NZS 1170.2 Section 2.4.1)

where:

$$\rho_{air} = 1.2\text{kg/m}^3$$

$$C_{dyn} = 1$$

$$p = 0.92 C_{fig} \text{ kn/m}^2$$

## 5.2 Pressure coefficients( $C_{fig}$ )

For internal pressure,  $C_{fig,i} = C_{p,i} K_{c,i}$  (AS/NZS 1170.2 Section 5.2)

For external pressure,  $C_{fig,e} = C_{p,e} K_a K_{c,e} K_l K_p$  (AS/NZS 1170.2 Section 5.2)

where

for windward permeable case,  $C_{p,i} = 0.6$  (AS/NZS 1170.2 Table 5.1(A))

$K_{c,i} = 0.8$  (AS/NZS 1170.2 Table 5.5)

$$C_{fig,i} = 0.6 \times 0.8 = 0.48$$

For external pressure,

Windward wall ( $C_{p,e}$ ) = 0.7 (wind speed taken for  $z=h$ ) (AS/NZS 1170.2 Table 5.2(A))

Leeward wall ( $C_{p,e}$ ) = -0.36 ( $\alpha=18^\circ$ ) (intermediate value of AS/NZS 1170.2 Table 5.2(B))

Side wall ( $C_{p,e}$ ) = -0.65 (AS/NZS 1170.2 Table 5.2(C))

Upwind roof ( $C_{p,e}$ ) = -0.40 (intermediate value of AS/NZS 1170.2 Table 5.3(B))

Downwind roof ( $C_{p,e}$ ) = -0.56 (intermediate value of AS/NZS 1170.2 Table 5.3(C))

$K_a = 1$  (AS/NZS 1170.2 Table 5.4)

$K_{c,e} = 0.8$  (AS/NZS 1170.2 Table 5.5)

$K_l = 1$  (AS/NZS 1170.2 Section 5.4.4)

$K_p = 0.8$  (AS/NZS 1170.2 Table 5.8)

$$C_{fig,i} = C_{p,e} \times 1 \times 0.8 \times 1 \times 0.8 = 0.64 C_{p,e}$$

Windward wall ( $C_{fig,e}$ ) = 0.512

Leeward wall ( $C_{fig,e}$ ) = -0.23

Side wall ( $C_{fig,e}$ ) = -0.416

Upwind roof ( $C_{fig,e}$ ) = -0.254

Downwind roof ( $C_{fig,e}$ ) = -0.358

## 5.3 Pressure forces (F)

$$F = \Sigma(p_z A_z) \quad (\text{AS/NZS 1170.2 Section 2.5.3})$$

➤ For the end bays

Windward wall (F) =  $0.92 \times 0.512 \times 2.5 = 1.178 \text{ KN/m}$

Leeward wall (F) =  $0.92 \times (-0.23) \times 2.5 = -0.529 \text{ KN/m}$

Side wall (F) =  $0.92 \times (-0.416) \times 2.5 = -0.957 \text{ KN/m}$

Upwind roof (F) =  $0.92 \times (-0.254) \times 2.5 = -0.584 \text{ KN/m}$

y-direction =  $0.584 \times \cos(18) = -0.56 \text{ KN/m}$

x-direction =  $0.584 \times \sin(18) = -0.18 \text{ KN/m}$

Downwind roof (F) =  $0.92 \times (-0.358) \times 2.5 = -0.823 \text{ KN/m}$

y-direction =  $-0.823 \times \cos(18) = -0.783 \text{ KN/m}$

x-direction =  $0.823 \times \sin(18) = -0.254 \text{ KN/m}$

➤ For the intermediate bays

Windward wall (F) =  $0.92 \times 0.512 \times 5 = 2.36 \text{ KN/m}$

Leeward wall (F) =  $0.92 \times (-0.23) \times 5 = -1.06 \text{ KN/m}$

Upwind roof (F) =  $0.92 \times (-0.254) \times 5 = -1.17 \text{ KN/m}$   
 y-direction =  $-1.17 \times \cos(18) = -1.11 \text{ KN/m}$   
 x-direction =  $-1.17 \times \sin(18) = -0.36 \text{ KN/m}$   
 Downwind roof F) =  $0.92 \times (-0.358) \times 5 = -1.65 \text{ KN/m}$   
 y-direction =  $-1.65 \times \cos(18) = -1.57 \text{ KN/m}$   
 x-direction =  $-1.65 \times \sin(18) = -0.51 \text{ KN/m}$

## 5.4 Load diagram

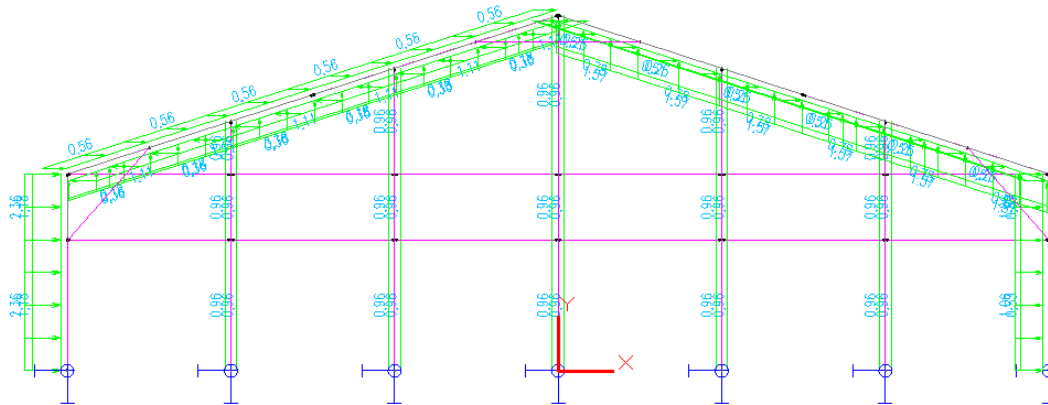

Figure 3 Load diagram of end bays

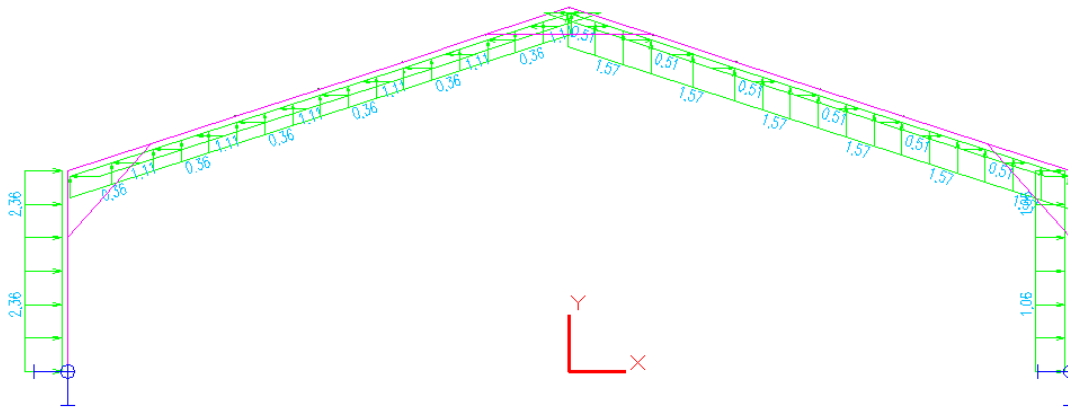

Figure 4 Load diagram of intermediate bays

## 5.5 Load combination

the combination of actions should be taken as:

- 1) 1.35G
- 2) 1.2G + W

(AS/NZS 1170.0 Section 4)

# 6 CALCULATION RESULTS

## 6.1 Calculation result of combination displacement

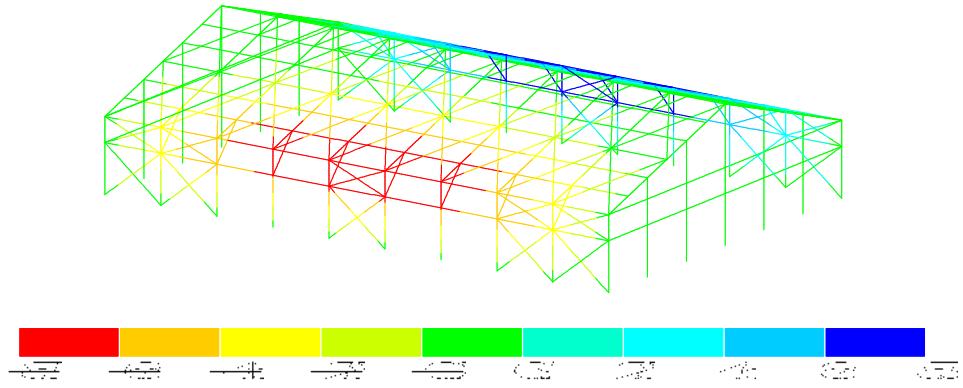

Figure 5 Ux of combination 1(mm)

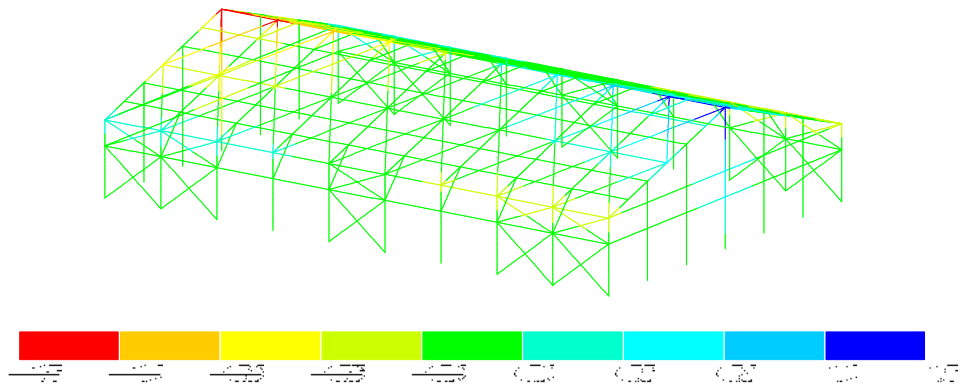

Figure 6 Uy of combination 1(mm)

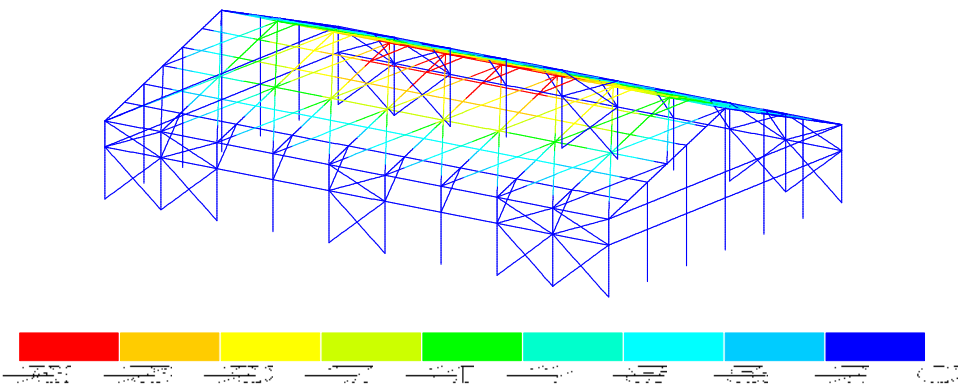

Figure 7 Uz of combination 1(mm)

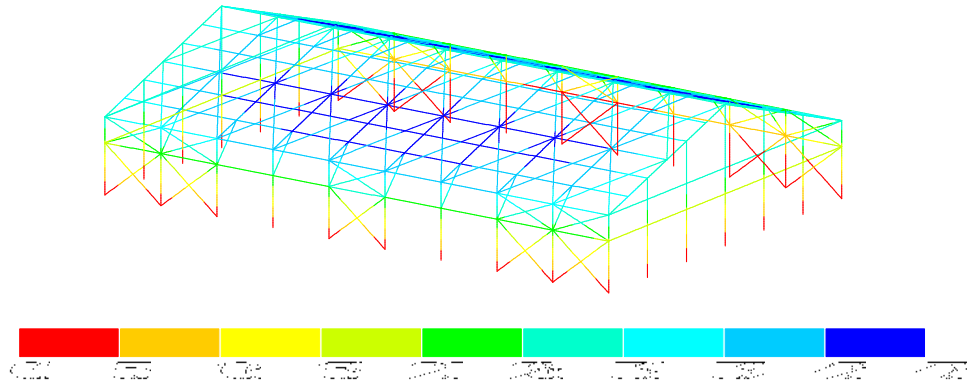

Figure 8  $U_x$  of combination 2(mm)

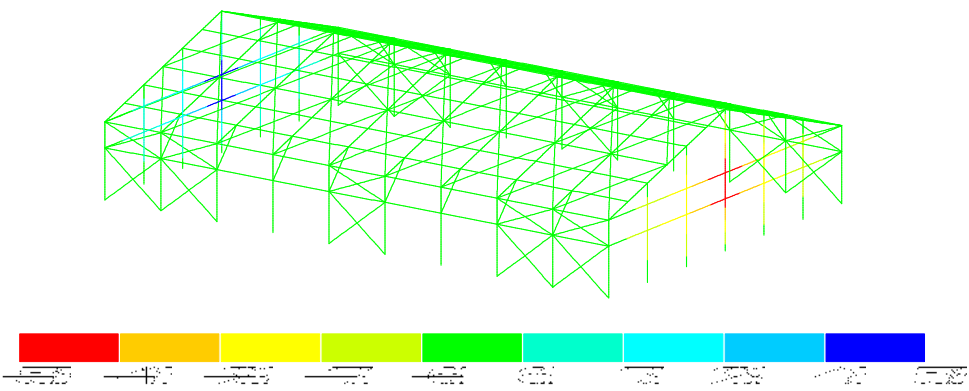

Figure 9  $U_y$  of combination 2(mm)

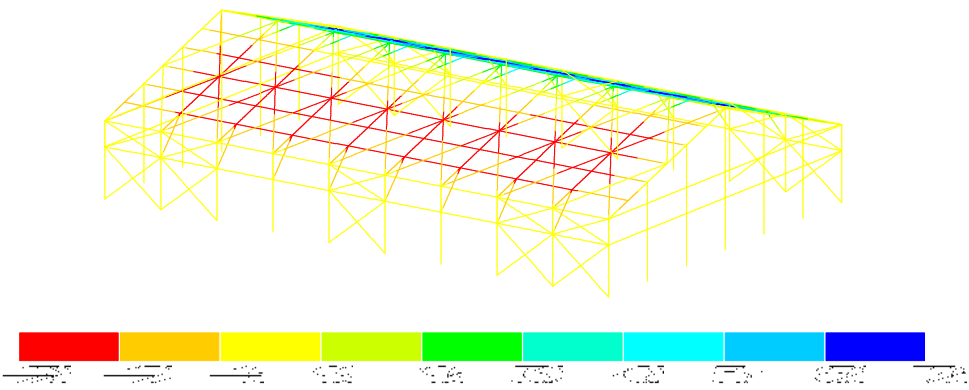

Figure 10  $U_z$  of Combination 2(mm)



## 6.2 Results of internal force with enclosure

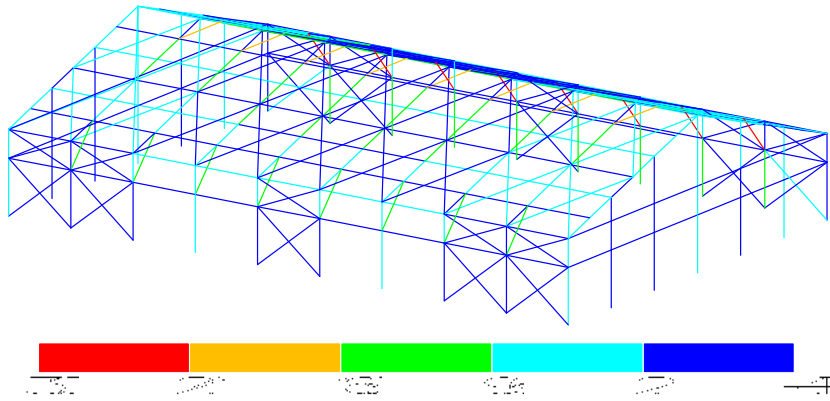

Figure 11 Colors display according to the maximum axial force N (KN)

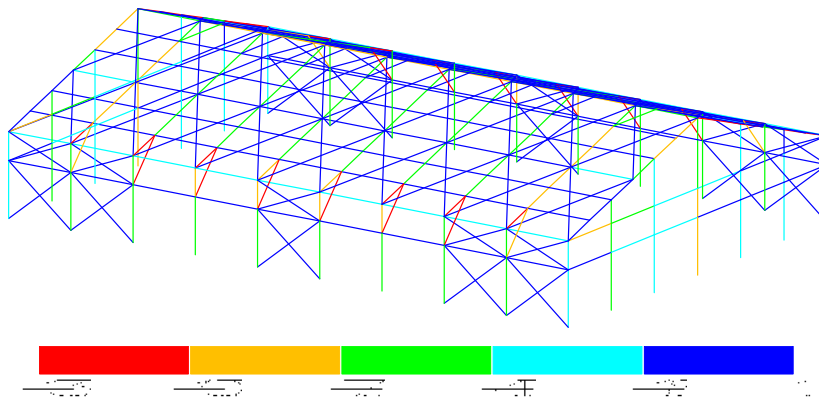

Figure 12 Colors display according to the minimum axial force N (KN)

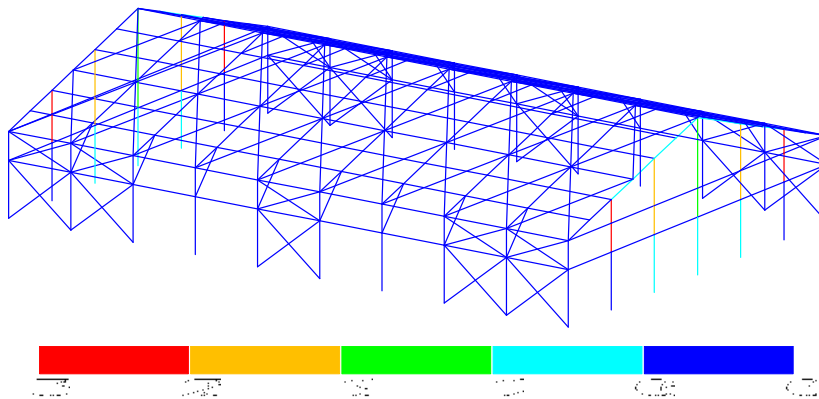

Figure 13 Colors display according to the maximum moment M2 (KN.m)

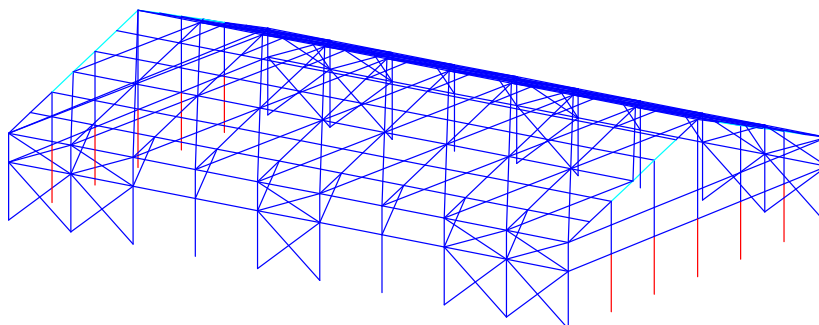



Figure 14 Colors display according to the minimum moment M2 (KN.m)

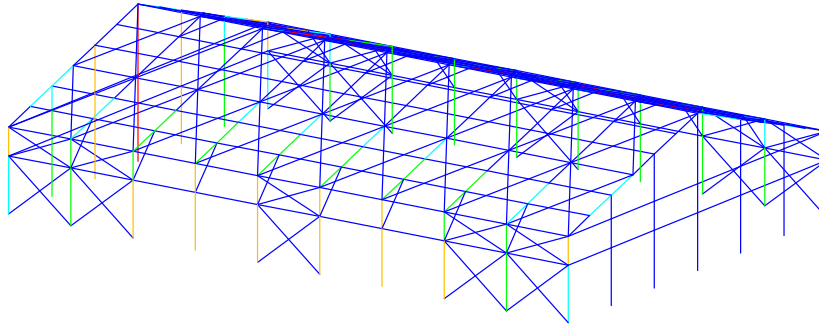

Figure 15 Colors display according to the maximum moment M3 (KN.m)

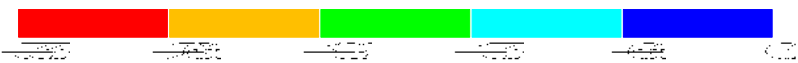
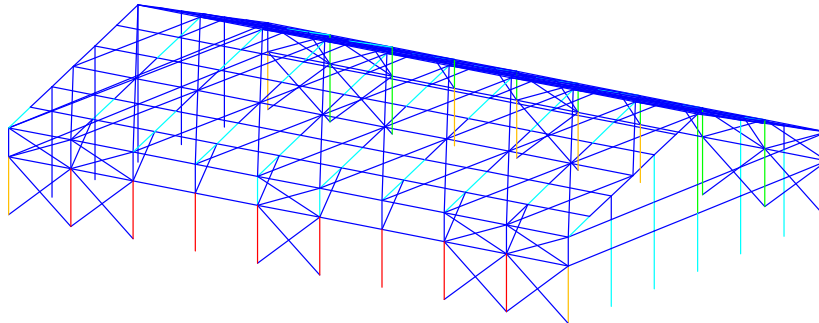

Figure 16 Colors display according to the minimum moment M3 (KN.m)

## 7 SUMMARY RESULTS

The calculation result shows that the structure can meet the requirements of bearing capacity, and the maximum stress ratio is **0.45**. General stress ratio layout of model is illustrated below:

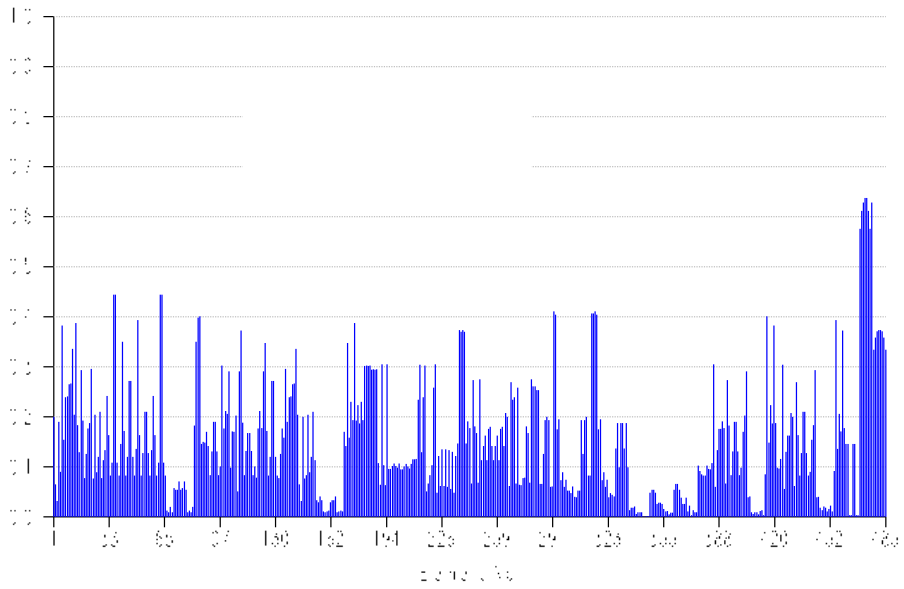

Figure 17 Summary result of elements stress ratio

## 7.1 Intensity

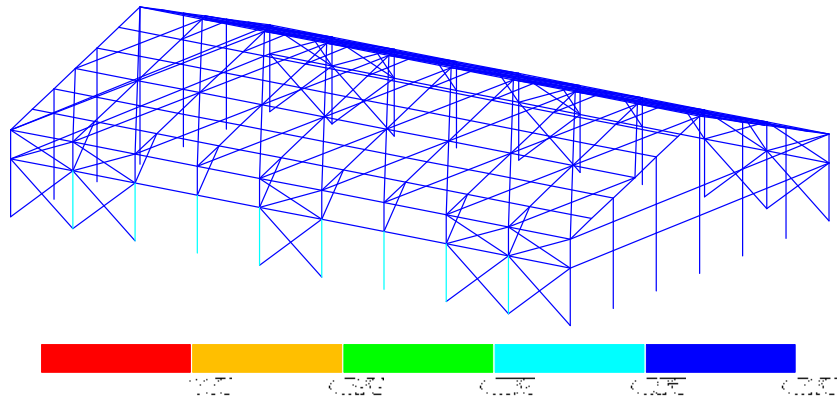

Figure 18 Summary result of the stress ratio of intensity

## 7.2 Stability of 2 axis

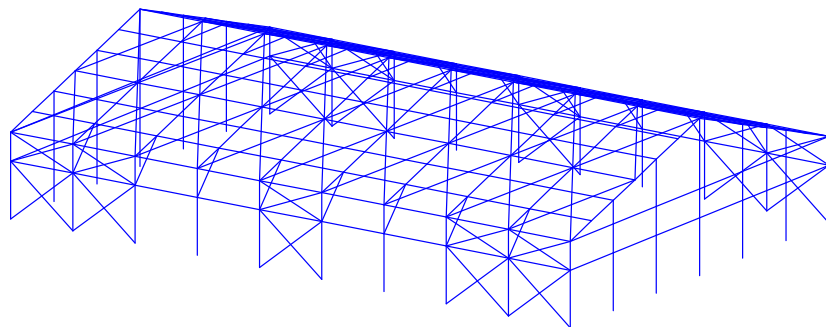



Figure 19 Summary result of the stress ratio of 2 axis stability

### 7.3 Stability of 3 axis

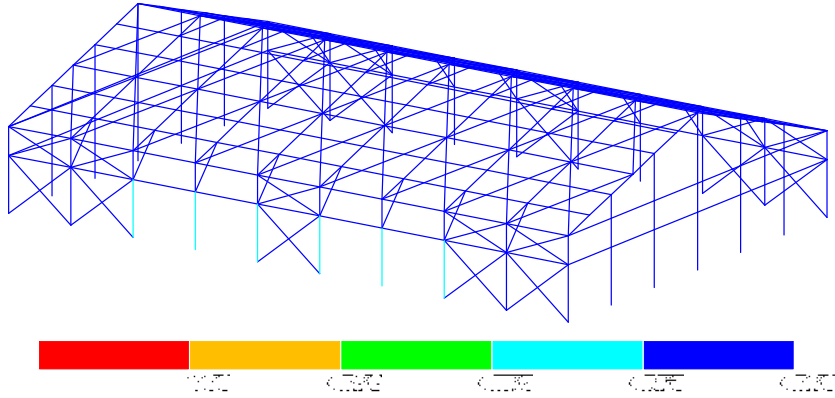

Figure 20 Summary result of the stress ratio of 3 axis stability

### 7.4 Total Design calculation results table

Elements No.	Intensity	The stress ratio of 2 axis stability	The stress ratio of 2 axis stability	The shear stress ratio of 2 axis	The shear stress ratio of 3axis	Result
1	0.201	0.140	0.171	0.008	0.001	Pass
2	0.034	0.065	0.056	0.002	0.000	Pass
3	0.032	0.017	0.025	0.001	0.000	Pass
4	0.190	0.139	0.166	0.005	0.001	Pass
5	0.091	0.057	0.080	0.002	0.002	Pass
6	0.383	0.284	0.336	0.018	0.001	Pass
7	0.154	0.112	0.155	0.003	0.001	Pass
8	0.240	0.161	0.200	0.004	0.020	Pass
9	0.241	0.162	0.202	0.007	0.029	Pass
10	0.265	0.192	0.230	0.004	0.021	Pass
11	0.267	0.191	0.230	0.007	0.029	Pass
12	0.061	0.336	0.217	0.001	0.000	Pass
13	0.048	0.205	0.136	0.002	0.000	Pass
14	0.388	0.287	0.341	0.018	0.000	Pass
15	0.184	0.112	0.138	0.013	0.001	Pass
16	0.129	0.072	0.104	0.002	0.004	Pass

Elements No.	Intensity	The stress ratio of 2 axis stability	The stress ratio of 2 axis stability	The shear stress ratio of 2 axis	The shear stress ratio of 3axis	Result
17	0.293	0.193	0.238	0.007	0.002	Pass
18	0.193	0.151	0.175	0.013	0.000	Pass
19	0.078	0.064	0.068	0.002	0.004	Pass
20	0.126	0.093	0.126	0.003	0.002	Pass
21	0.177	0.112	0.138	0.012	0.002	Pass
22	0.188	0.148	0.171	0.013	0.001	Pass
23	0.297	0.200	0.248	0.007	0.004	Pass
24	0.077	0.048	0.063	0.002	0.007	Pass
25	0.204	0.140	0.170	0.004	0.001	Pass
26	0.090	0.054	0.067	0.005	0.004	Pass
27	0.120	0.112	0.117	0.006	0.004	Pass
28	0.210	0.177	0.195	0.004	0.001	Pass
29	0.075	0.078	0.078	0.002	0.006	Pass
30	0.111	0.089	0.114	0.003	0.008	Pass
31	0.042	0.134	0.097	0.002	0.000	Pass
32	0.058	0.242	0.161	0.002	0.000	Pass
33	0.045	0.164	0.114	0.002	0.000	Pass
34	0.082	0.058	0.083	0.003	0.000	Pass
35	0.102	0.083	0.108	0.003	0.000	Pass
36	0.112	0.415	0.445	0.003	0.000	Pass
37	0.112	0.423	0.445	0.003	0.000	Pass
38	0.102	0.083	0.108	0.003	0.000	Pass
39	0.082	0.058	0.083	0.003	0.000	Pass
40	0.043	0.147	0.104	0.002	0.000	Pass
41	0.070	0.350	0.230	0.002	0.000	Pass
42	0.046	0.172	0.118	0.002	0.000	Pass
43	0.083	0.057	0.082	0.003	0.000	Pass
44	0.098	0.095	0.121	0.003	0.000	Pass
45	0.098	0.242	0.272	0.003	0.000	Pass
46	0.098	0.242	0.272	0.003	0.000	Pass
47	0.098	0.095	0.121	0.003	0.000	Pass
48	0.083	0.057	0.082	0.003	0.000	Pass
49	0.042	0.136	0.098	0.002	0.000	Pass
50	0.081	0.394	0.256	0.002	0.000	Pass
51	0.045	0.164	0.114	0.002	0.000	Pass
52	0.083	0.057	0.082	0.003	0.000	Pass
53	0.096	0.102	0.128	0.003	0.000	Pass

Elements No.	Intensity	The stress ratio of 2 axis stability	The stress ratio of 2 axis stability	The shear stress ratio of 2 axis	The shear stress ratio of 3axis	Result
54	0.093	0.182	0.210	0.003	0.000	Pass
55	0.093	0.182	0.210	0.003	0.000	Pass
56	0.096	0.102	0.128	0.003	0.000	Pass
57	0.083	0.057	0.082	0.003	0.000	Pass
58	0.042	0.134	0.097	0.002	0.000	Pass
59	0.058	0.242	0.161	0.002	0.000	Pass
60	0.045	0.164	0.114	0.002	0.000	Pass
61	0.082	0.058	0.083	0.003	0.000	Pass
62	0.102	0.083	0.108	0.003	0.000	Pass
63	0.112	0.415	0.445	0.003	0.000	Pass
64	0.112	0.423	0.445	0.003	0.000	Pass
65	0.102	0.083	0.108	0.003	0.000	Pass
66	0.082	0.058	0.083	0.003	0.000	Pass
67	0.013	0.000	0.000	0.000	0.000	Pass
68	0.010	0.000	0.000	0.000	0.000	Pass
69	0.020	0.000	0.000	0.000	0.000	Pass
70	0.010	0.000	0.000	0.000	0.000	Pass
71	0.058	0.000	0.000	0.000	0.000	Pass
72	0.054	0.000	0.000	0.000	0.000	Pass
73	0.054	0.000	0.000	0.000	0.000	Pass
74	0.071	0.000	0.000	0.000	0.000	Pass
75	0.054	0.000	0.000	0.000	0.000	Pass
76	0.058	0.000	0.000	0.000	0.000	Pass
77	0.071	0.000	0.000	0.000	0.000	Pass
78	0.054	0.000	0.000	0.000	0.000	Pass
79	0.010	0.000	0.000	0.000	0.000	Pass
80	0.013	0.000	0.000	0.000	0.000	Pass
81	0.010	0.000	0.000	0.000	0.000	Pass
82	0.020	0.000	0.000	0.000	0.000	Pass
83	0.047	0.183	0.124	0.002	0.000	Pass
84	0.070	0.350	0.230	0.002	0.000	Pass
85	0.089	0.399	0.260	0.002	0.000	Pass
86	0.087	0.401	0.261	0.002	0.000	Pass
87	0.043	0.147	0.104	0.002	0.000	Pass
88	0.046	0.150	0.106	0.002	0.000	Pass
89	0.046	0.149	0.105	0.002	0.000	Pass
90	0.170	0.155	0.166	0.008	0.001	Pass

Elements No.	Intensity	The stress ratio of 2 axis stability	The stress ratio of 2 axis stability	The shear stress ratio of 2 axis	The shear stress ratio of 3axis	Result
91	0.142	0.122	0.134	0.006	0.001	Pass
92	0.084	0.057	0.082	0.003	0.000	Pass
93	0.095	0.105	0.131	0.003	0.000	Pass
94	0.092	0.163	0.190	0.003	0.000	Pass
95	0.092	0.163	0.190	0.003	0.000	Pass
96	0.095	0.105	0.131	0.003	0.000	Pass
97	0.084	0.057	0.082	0.003	0.000	Pass
98	0.102	0.059	0.088	0.002	0.000	Pass
99	0.303	0.198	0.246	0.004	0.005	Pass
100	0.176	0.126	0.177	0.004	0.000	Pass
101	0.212	0.127	0.158	0.013	0.000	Pass
102	0.206	0.179	0.195	0.010	0.001	Pass
103	0.291	0.187	0.230	0.008	0.000	Pass
104	0.098	0.057	0.086	0.002	0.001	Pass
105	0.171	0.141	0.158	0.007	0.001	Pass
106	0.169	0.121	0.171	0.003	0.001	Pass
107	0.203	0.123	0.152	0.013	0.001	Pass
108	0.051	0.038	0.047	0.001	0.008	Pass
109	0.291	0.189	0.233	0.007	0.001	Pass
110	0.373	0.276	0.327	0.018	0.002	Pass
111	0.047	0.188	0.127	0.002	0.000	Pass
112	0.084	0.057	0.082	0.003	0.000	Pass
113	0.095	0.106	0.132	0.003	0.000	Pass
114	0.090	0.141	0.168	0.003	0.000	Pass
115	0.090	0.141	0.168	0.003	0.000	Pass
116	0.094	0.106	0.132	0.003	0.000	Pass
117	0.084	0.057	0.082	0.003	0.000	Pass
118	0.102	0.059	0.088	0.002	0.000	Pass
119	0.076	0.075	0.079	0.003	0.008	Pass
120	0.176	0.126	0.177	0.004	0.000	Pass
121	0.212	0.127	0.158	0.013	0.000	Pass
122	0.178	0.140	0.161	0.012	0.001	Pass
123	0.291	0.187	0.230	0.008	0.000	Pass
124	0.348	0.256	0.304	0.016	0.002	Pass
125	0.046	0.172	0.118	0.002	0.000	Pass
126	0.083	0.057	0.082	0.003	0.000	Pass
127	0.098	0.095	0.121	0.003	0.000	Pass

Elements No.	Intensity	The stress ratio of 2 axis stability	The stress ratio of 2 axis stability	The shear stress ratio of 2 axis	The shear stress ratio of 3axis	Result
128	0.098	0.242	0.272	0.003	0.000	Pass
129	0.098	0.242	0.272	0.003	0.000	Pass
130	0.098	0.095	0.121	0.003	0.000	Pass
131	0.083	0.057	0.082	0.003	0.000	Pass
132	0.078	0.064	0.068	0.002	0.004	Pass
133	0.126	0.093	0.126	0.003	0.002	Pass
134	0.177	0.112	0.138	0.012	0.002	Pass
135	0.159	0.124	0.144	0.011	0.002	Pass
136	0.297	0.200	0.248	0.007	0.004	Pass
137	0.190	0.139	0.166	0.005	0.001	Pass
138	0.240	0.161	0.200	0.004	0.020	Pass
139	0.241	0.162	0.202	0.007	0.029	Pass
140	0.265	0.192	0.230	0.004	0.021	Pass
141	0.267	0.191	0.230	0.007	0.029	Pass
142	0.061	0.336	0.217	0.001	0.000	Pass
143	0.048	0.205	0.136	0.002	0.000	Pass
144	0.034	0.065	0.056	0.002	0.000	Pass
145	0.032	0.017	0.025	0.001	0.000	Pass
146	0.201	0.140	0.171	0.008	0.001	Pass
147	0.077	0.048	0.063	0.002	0.007	Pass
148	0.074	0.080	0.084	0.002	0.008	Pass
149	0.204	0.140	0.170	0.004	0.001	Pass
150	0.090	0.054	0.067	0.005	0.004	Pass
151	0.120	0.112	0.117	0.006	0.004	Pass
152	0.210	0.177	0.195	0.004	0.001	Pass
153	0.111	0.089	0.114	0.003	0.008	Pass
154	0.034	0.000	0.000	0.000	0.000	Pass
155	0.030	0.000	0.000	0.000	0.000	Pass
156	0.041	0.000	0.000	0.000	0.000	Pass
157	0.034	0.000	0.000	0.000	0.000	Pass
158	0.012	0.000	0.000	0.000	0.000	Pass
159	0.010	0.000	0.000	0.000	0.000	Pass
160	0.012	0.000	0.000	0.000	0.000	Pass
161	0.013	0.000	0.000	0.000	0.000	Pass
162	0.030	0.000	0.000	0.000	0.000	Pass
163	0.034	0.000	0.000	0.000	0.000	Pass
164	0.034	0.000	0.000	0.000	0.000	Pass



Elements No.	Intensity	The stress ratio of 2 axis stability	The stress ratio of 2 axis stability	The shear stress ratio of 2 axis	The shear stress ratio of 3axis	Result
165	0.041	0.000	0.000	0.000	0.000	Pass
166	0.010	0.000	0.000	0.000	0.000	Pass
167	0.012	0.000	0.000	0.000	0.000	Pass
168	0.013	0.000	0.000	0.000	0.000	Pass
169	0.012	0.000	0.000	0.000	0.000	Pass
170	0.170	0.155	0.166	0.008	0.001	Pass
171	0.142	0.122	0.134	0.006	0.001	Pass
172	0.348	0.256	0.304	0.016	0.002	Pass
173	0.159	0.124	0.144	0.011	0.002	Pass
174	0.231	0.193	0.214	0.011	0.000	Pass
175	0.194	0.156	0.177	0.008	0.000	Pass
176	0.388	0.287	0.341	0.018	0.000	Pass
177	0.193	0.151	0.175	0.013	0.000	Pass
178	0.224	0.189	0.209	0.011	0.000	Pass
179	0.187	0.152	0.171	0.008	0.000	Pass
180	0.231	0.193	0.214	0.011	0.000	Pass
181	0.194	0.156	0.177	0.008	0.000	Pass
182	0.302	0.211	0.281	0.003	0.012	Pass
183	0.303	0.213	0.280	0.008	0.010	Pass
184	0.302	0.211	0.281	0.003	0.012	Pass
185	0.303	0.213	0.280	0.008	0.010	Pass
186	0.295	0.202	0.272	0.003	0.012	Pass
187	0.295	0.202	0.272	0.008	0.010	Pass
188	0.295	0.202	0.272	0.003	0.012	Pass
189	0.295	0.202	0.272	0.008	0.010	Pass
190	0.108	0.064	0.081	0.002	0.001	Pass
191	0.062	0.056	0.065	0.001	0.008	Pass
192	0.306	0.198	0.244	0.003	0.001	Pass
193	0.103	0.064	0.077	0.002	0.000	Pass
194	0.061	0.061	0.064	0.001	0.006	Pass
195	0.306	0.198	0.244	0.003	0.000	Pass
196	0.097	0.069	0.094	0.003	0.000	Pass
197	0.096	0.068	0.093	0.003	0.000	Pass
198	0.102	0.071	0.096	0.003	0.000	Pass
199	0.107	0.070	0.095	0.003	0.000	Pass
200	0.102	0.071	0.096	0.003	0.000	Pass
201	0.098	0.070	0.095	0.003	0.000	Pass

Elements No.	Intensity	The stress ratio of 2 axis stability	The stress ratio of 2 axis stability	The shear stress ratio of 2 axis	The shear stress ratio of 3axis	Result
202	0.107	0.070	0.095	0.003	0.000	Pass
203	0.096	0.069	0.094	0.003	0.000	Pass
204	0.095	0.068	0.093	0.003	0.000	Pass
205	0.101	0.071	0.096	0.003	0.000	Pass
206	0.107	0.070	0.095	0.003	0.000	Pass
207	0.101	0.071	0.096	0.003	0.000	Pass
208	0.097	0.070	0.095	0.003	0.000	Pass
209	0.107	0.070	0.095	0.003	0.000	Pass
210	0.039	0.115	0.087	0.002	0.000	Pass
211	0.039	0.115	0.087	0.002	0.000	Pass
212	0.117	0.065	0.089	0.002	0.002	Pass
213	0.234	0.141	0.209	0.004	0.005	Pass
214	0.304	0.198	0.244	0.004	0.002	Pass
215	0.129	0.072	0.104	0.002	0.004	Pass
216	0.235	0.177	0.239	0.006	0.005	Pass
217	0.303	0.198	0.246	0.004	0.005	Pass
218	0.051	0.038	0.047	0.001	0.008	Pass
219	0.067	0.064	0.067	0.005	0.005	Pass
220	0.074	0.080	0.084	0.002	0.008	Pass
221	0.103	0.064	0.077	0.002	0.000	Pass
222	0.259	0.164	0.204	0.010	0.005	Pass
223	0.306	0.198	0.244	0.003	0.000	Pass
224	0.048	0.034	0.037	0.001	0.000	Pass
225	0.122	0.034	0.037	0.003	0.000	Pass
226	0.062	0.050	0.055	0.001	0.000	Pass
227	0.135	0.050	0.055	0.002	0.000	Pass
228	0.062	0.050	0.055	0.001	0.000	Pass
229	0.135	0.050	0.055	0.002	0.000	Pass
230	0.060	0.048	0.053	0.001	0.000	Pass
231	0.134	0.048	0.053	0.002	0.000	Pass
232	0.056	0.043	0.047	0.001	0.000	Pass
233	0.130	0.043	0.047	0.002	0.000	Pass
234	0.048	0.034	0.037	0.001	0.000	Pass
235	0.122	0.034	0.037	0.003	0.000	Pass
236	0.043	0.147	0.104	0.002	0.000	Pass
237	0.373	0.353	0.358	0.003	0.007	不足
238	0.370	0.319	0.355	0.010	0.005	不足

Elements No.	Intensity	The stress ratio of 2 axis stability	The stress ratio of 2 axis stability	The shear stress ratio of 2 axis	The shear stress ratio of 3axis	Result
239	0.373	0.353	0.358	0.003	0.007	不足
240	0.370	0.319	0.355	0.010	0.005	不足
241	0.043	0.147	0.104	0.002	0.000	Pass
242	0.191	0.108	0.162	0.003	0.002	Pass
243	0.178	0.126	0.178	0.005	0.002	Pass
244	0.067	0.053	0.058	0.006	0.002	Pass
245	0.274	0.173	0.214	0.009	0.002	Pass
246	0.181	0.102	0.154	0.003	0.001	Pass
247	0.167	0.119	0.168	0.005	0.001	Pass
248	0.068	0.060	0.062	0.006	0.001	Pass
249	0.276	0.175	0.216	0.009	0.001	Pass
250	0.086	0.088	0.114	0.003	0.000	Pass
251	0.088	0.115	0.142	0.003	0.000	Pass
252	0.090	0.136	0.163	0.003	0.000	Pass
253	0.086	0.088	0.114	0.003	0.000	Pass
254	0.093	0.149	0.176	0.003	0.000	Pass
255	0.093	0.153	0.180	0.003	0.000	Pass
256	0.088	0.115	0.142	0.003	0.000	Pass
257	0.086	0.088	0.114	0.003	0.000	Pass
258	0.088	0.115	0.142	0.003	0.000	Pass
259	0.090	0.136	0.163	0.003	0.000	Pass
260	0.086	0.088	0.114	0.003	0.000	Pass
261	0.093	0.149	0.176	0.003	0.000	Pass
262	0.094	0.153	0.180	0.003	0.000	Pass
263	0.088	0.115	0.142	0.003	0.000	Pass
264	0.208	0.121	0.180	0.004	0.003	Pass
265	0.199	0.144	0.200	0.005	0.004	Pass
266	0.062	0.048	0.056	0.005	0.004	Pass
267	0.270	0.170	0.211	0.009	0.003	Pass
268	0.234	0.141	0.209	0.004	0.005	Pass
269	0.235	0.177	0.239	0.006	0.005	Pass
270	0.067	0.064	0.067	0.005	0.005	Pass
271	0.259	0.164	0.204	0.010	0.005	Pass
272	0.062	0.056	0.065	0.001	0.008	Pass
273	0.061	0.061	0.064	0.001	0.006	Pass
274	0.075	0.078	0.078	0.002	0.006	Pass
275	0.076	0.075	0.079	0.003	0.008	Pass

Elements No.	Intensity	The stress ratio of 2 axis stability	The stress ratio of 2 axis stability	The shear stress ratio of 2 axis	The shear stress ratio of 3axis	Result
276	0.181	0.102	0.154	0.003	0.001	Pass
277	0.167	0.119	0.168	0.005	0.001	Pass
278	0.068	0.060	0.062	0.006	0.001	Pass
279	0.276	0.175	0.216	0.009	0.001	Pass
280	0.261	0.195	0.259	0.008	0.015	Pass
281	0.261	0.195	0.259	0.008	0.015	Pass
282	0.254	0.176	0.248	0.008	0.015	Pass
283	0.254	0.176	0.248	0.008	0.015	Pass
284	0.040	0.066	0.061	0.002	0.000	Pass
285	0.040	0.066	0.061	0.002	0.000	Pass
286	0.091	0.102	0.126	0.004	0.000	Pass
287	0.100	0.162	0.193	0.004	0.000	Pass
288	0.092	0.171	0.200	0.004	0.000	Pass
289	0.100	0.162	0.193	0.004	0.000	Pass
290	0.041	0.061	0.057	0.002	0.000	Pass
291	0.039	0.061	0.058	0.002	0.000	Pass
292	0.412	0.288	0.350	0.012	0.000	Pass
293	0.404	0.297	0.348	0.011	0.001	Pass
294	0.175	0.114	0.162	0.007	0.013	Pass
295	0.195	0.176	0.195	0.007	0.013	Pass
296	0.041	0.074	0.065	0.002	0.000	Pass
297	0.042	0.089	0.075	0.002	0.000	Pass
298	0.040	0.060	0.057	0.002	0.000	Pass
299	0.041	0.075	0.066	0.002	0.000	Pass
300	0.039	0.053	0.053	0.002	0.000	Pass
301	0.039	0.053	0.052	0.002	0.000	Pass
302	0.039	0.046	0.048	0.002	0.000	Pass
303	0.039	0.061	0.058	0.002	0.000	Pass
304	0.039	0.033	0.040	0.002	0.000	Pass
305	0.039	0.026	0.038	0.002	0.000	Pass
306	0.039	0.053	0.053	0.002	0.000	Pass
307	0.039	0.053	0.052	0.002	0.000	Pass
308	0.100	0.162	0.193	0.004	0.000	Pass
309	0.091	0.102	0.126	0.004	0.000	Pass
310	0.100	0.162	0.193	0.004	0.000	Pass
311	0.092	0.171	0.200	0.004	0.000	Pass
312	0.042	0.083	0.071	0.002	0.000	Pass

Elements No.	Intensity	The stress ratio of 2 axis stability	The stress ratio of 2 axis stability	The shear stress ratio of 2 axis	The shear stress ratio of 3axis	Result
313	0.042	0.083	0.071	0.002	0.000	Pass
314	0.328	0.407	0.322	0.010	0.015	不足
315	0.328	0.407	0.322	0.010	0.015	不足
316	0.412	0.288	0.350	0.012	0.000	Pass
317	0.404	0.297	0.348	0.011	0.001	Pass
318	0.175	0.114	0.162	0.007	0.013	Pass
319	0.195	0.176	0.195	0.007	0.013	Pass
320	0.041	0.074	0.065	0.002	0.000	Pass
321	0.042	0.089	0.075	0.002	0.000	Pass
322	0.040	0.060	0.057	0.002	0.000	Pass
323	0.041	0.075	0.066	0.002	0.000	Pass
324	0.040	0.026	0.038	0.002	0.000	Pass
325	0.039	0.046	0.048	0.002	0.000	Pass
326	0.041	0.040	0.044	0.002	0.000	Pass
327	0.040	0.035	0.042	0.002	0.000	Pass
328	0.091	0.113	0.137	0.004	0.000	Pass
329	0.100	0.157	0.188	0.004	0.000	Pass
330	0.091	0.075	0.099	0.004	0.000	Pass
331	0.100	0.157	0.188	0.004	0.000	Pass
332	0.100	0.157	0.188	0.004	0.000	Pass
333	0.091	0.113	0.137	0.004	0.000	Pass
334	0.100	0.157	0.188	0.004	0.000	Pass
335	0.091	0.075	0.099	0.004	0.000	Pass
336	0.014	0.000	0.000	0.000	0.000	Pass
337	0.019	0.000	0.000	0.000	0.000	Pass
338	0.019	0.000	0.000	0.000	0.000	Pass
339	0.021	0.000	0.000	0.000	0.000	Pass
340	0.006	0.000	0.000	0.000	0.000	Pass
341	0.009	0.000	0.000	0.000	0.000	Pass
342	0.009	0.000	0.000	0.000	0.000	Pass
343	0.009	0.000	0.000	0.000	0.000	Pass
344	0.001	0.000	0.000	0.000	0.000	Pass
345	0.001	0.000	0.000	0.000	0.000	Pass
346	0.002	0.000	0.000	0.000	0.000	Pass
347	0.002	0.000	0.000	0.000	0.000	Pass
348	0.049	0.000	0.000	0.000	0.000	Pass
349	0.055	0.000	0.000	0.000	0.000	Pass

Elements No.	Intensity	The stress ratio of 2 axis stability	The stress ratio of 2 axis stability	The shear stress ratio of 2 axis	The shear stress ratio of 3axis	Result
350	0.055	0.000	0.000	0.000	0.000	Pass
351	0.049	0.000	0.000	0.000	0.000	Pass
352	0.026	0.000	0.000	0.000	0.000	Pass
353	0.029	0.000	0.000	0.000	0.000	Pass
354	0.029	0.000	0.000	0.000	0.000	Pass
355	0.026	0.000	0.000	0.000	0.000	Pass
356	0.017	0.000	0.000	0.000	0.000	Pass
357	0.011	0.000	0.000	0.000	0.000	Pass
358	0.012	0.000	0.000	0.000	0.000	Pass
359	0.005	0.000	0.000	0.000	0.000	Pass
360	0.009	0.000	0.000	0.000	0.000	Pass
361	0.009	0.000	0.000	0.000	0.000	Pass
362	0.055	0.000	0.000	0.000	0.000	Pass
363	0.067	0.000	0.000	0.000	0.000	Pass
364	0.067	0.000	0.000	0.000	0.000	Pass
365	0.055	0.000	0.000	0.000	0.000	Pass
366	0.039	0.000	0.000	0.000	0.000	Pass
367	0.026	0.000	0.000	0.000	0.000	Pass
368	0.026	0.000	0.000	0.000	0.000	Pass
369	0.039	0.000	0.000	0.000	0.000	Pass
370	0.011	0.000	0.000	0.000	0.000	Pass
371	0.023	0.000	0.000	0.000	0.000	Pass
372	0.004	0.000	0.000	0.000	0.000	Pass
373	0.014	0.000	0.000	0.000	0.000	Pass
374	0.009	0.000	0.000	0.000	0.000	Pass
375	0.009	0.000	0.000	0.000	0.000	Pass
376	0.103	0.019	0.021	0.003	0.000	Pass
377	0.092	0.009	0.010	0.003	0.000	Pass
378	0.086	0.005	0.007	0.003	0.000	Pass
379	0.083	0.003	0.005	0.003	0.000	Pass
380	0.083	0.003	0.005	0.003	0.000	Pass
381	0.103	0.019	0.021	0.003	0.000	Pass
382	0.097	0.069	0.094	0.003	0.000	Pass
383	0.096	0.069	0.094	0.003	0.000	Pass
384	0.108	0.064	0.081	0.002	0.001	Pass
385	0.306	0.198	0.244	0.003	0.001	Pass
386	0.060	0.048	0.053	0.001	0.000	Pass

Elements No.	Intensity	The stress ratio of 2 axis stability	The stress ratio of 2 axis stability	The shear stress ratio of 2 axis	The shear stress ratio of 3axis	Result
387	0.134	0.048	0.053	0.002	0.000	Pass
388	0.093	0.149	0.176	0.003	0.000	Pass
389	0.093	0.149	0.176	0.003	0.000	Pass
390	0.191	0.108	0.162	0.003	0.002	Pass
391	0.178	0.126	0.178	0.005	0.002	Pass
392	0.067	0.053	0.058	0.006	0.002	Pass
393	0.274	0.173	0.214	0.009	0.002	Pass
394	0.047	0.183	0.124	0.002	0.000	Pass
395	0.084	0.057	0.082	0.003	0.000	Pass
396	0.095	0.105	0.131	0.003	0.000	Pass
397	0.092	0.163	0.190	0.003	0.000	Pass
398	0.092	0.163	0.190	0.003	0.000	Pass
399	0.095	0.105	0.131	0.003	0.000	Pass
400	0.084	0.057	0.082	0.003	0.000	Pass
401	0.098	0.057	0.086	0.002	0.001	Pass
402	0.169	0.121	0.171	0.003	0.001	Pass
403	0.203	0.123	0.152	0.013	0.001	Pass
404	0.291	0.189	0.233	0.007	0.001	Pass
405	0.040	0.026	0.038	0.002	0.000	Pass
406	0.040	0.035	0.042	0.002	0.000	Pass
407	0.009	0.000	0.000	0.000	0.000	Pass
408	0.006	0.000	0.000	0.000	0.000	Pass
409	0.009	0.000	0.000	0.000	0.000	Pass
410	0.009	0.000	0.000	0.000	0.000	Pass
411	0.005	0.000	0.000	0.000	0.000	Pass
412	0.012	0.000	0.000	0.000	0.000	Pass
413	0.014	0.000	0.000	0.000	0.000	Pass
414	0.004	0.000	0.000	0.000	0.000	Pass
415	0.086	0.005	0.007	0.003	0.000	Pass
416	0.087	0.401	0.261	0.002	0.000	Pass
417	0.046	0.149	0.105	0.002	0.000	Pass
418	0.224	0.189	0.209	0.011	0.000	Pass
419	0.187	0.152	0.171	0.008	0.000	Pass
420	0.383	0.284	0.336	0.018	0.001	Pass
421	0.188	0.148	0.171	0.013	0.001	Pass
422	0.098	0.070	0.095	0.003	0.000	Pass
423	0.097	0.070	0.095	0.003	0.000	Pass

Elements No.	Intensity	The stress ratio of 2 axis stability	The stress ratio of 2 axis stability	The shear stress ratio of 2 axis	The shear stress ratio of 3axis	Result
424	0.117	0.065	0.089	0.002	0.002	Pass
425	0.304	0.198	0.244	0.004	0.002	Pass
426	0.056	0.043	0.047	0.001	0.000	Pass
427	0.130	0.043	0.047	0.002	0.000	Pass
428	0.090	0.136	0.163	0.003	0.000	Pass
429	0.090	0.136	0.163	0.003	0.000	Pass
430	0.208	0.121	0.180	0.004	0.003	Pass
431	0.199	0.144	0.200	0.005	0.004	Pass
432	0.062	0.048	0.056	0.005	0.004	Pass
433	0.270	0.170	0.211	0.009	0.003	Pass
434	0.045	0.164	0.114	0.002	0.000	Pass
435	0.083	0.057	0.082	0.003	0.000	Pass
436	0.096	0.102	0.128	0.003	0.000	Pass
437	0.093	0.182	0.210	0.003	0.000	Pass
438	0.093	0.182	0.210	0.003	0.000	Pass
439	0.096	0.102	0.128	0.003	0.000	Pass
440	0.083	0.057	0.082	0.003	0.000	Pass
441	0.091	0.057	0.080	0.002	0.002	Pass
442	0.154	0.112	0.155	0.003	0.001	Pass
443	0.184	0.112	0.138	0.013	0.001	Pass
444	0.293	0.193	0.238	0.007	0.002	Pass
445	0.039	0.026	0.038	0.002	0.000	Pass
446	0.039	0.033	0.040	0.002	0.000	Pass
447	0.019	0.000	0.000	0.000	0.000	Pass
448	0.014	0.000	0.000	0.000	0.000	Pass
449	0.021	0.000	0.000	0.000	0.000	Pass
450	0.019	0.000	0.000	0.000	0.000	Pass
451	0.011	0.000	0.000	0.000	0.000	Pass
452	0.017	0.000	0.000	0.000	0.000	Pass
453	0.023	0.000	0.000	0.000	0.000	Pass
454	0.011	0.000	0.000	0.000	0.000	Pass
455	0.092	0.009	0.010	0.003	0.000	Pass
456	0.081	0.394	0.256	0.002	0.000	Pass
457	0.042	0.136	0.098	0.002	0.000	Pass
458	0.206	0.179	0.195	0.010	0.001	Pass
459	0.171	0.141	0.158	0.007	0.001	Pass
460	0.373	0.276	0.327	0.018	0.002	Pass



Elements No.	Intensity	The stress ratio of 2 axis stability	The stress ratio of 2 axis stability	The shear stress ratio of 2 axis	The shear stress ratio of 3axis	Result
461	0.178	0.140	0.161	0.012	0.001	Pass
462	0.096	0.118	0.146	0.004	0.000	Pass
463	0.096	0.118	0.146	0.004	0.000	Pass
464	0.004	0.000	0.000	0.000	0.000	Pass
465	0.004	0.000	0.000	0.000	0.000	Pass
466	0.096	0.118	0.146	0.004	0.000	Pass
467	0.096	0.118	0.146	0.004	0.000	Pass
468	0.004	0.000	0.000	0.000	0.000	Pass
469	0.004	0.000	0.000	0.000	0.000	Pass
470	0.576	0.403	0.490	0.021	0.000	Pass
471	0.612	0.428	0.520	0.022	0.000	Pass
472	0.629	0.440	0.535	0.022	0.000	Pass
473	0.638	0.446	0.542	0.023	0.000	Pass
474	0.638	0.446	0.542	0.023	0.000	Pass
475	0.612	0.428	0.520	0.022	0.000	Pass
476	0.576	0.403	0.490	0.021	0.000	Pass
477	0.629	0.440	0.535	0.022	0.000	Pass
478	0.335	0.229	0.332	0.010	0.001	Pass
479	0.359	0.245	0.300	0.011	0.000	Pass
480	0.372	0.249	0.306	0.012	0.000	Pass
481	0.374	0.253	0.311	0.012	0.000	Pass
482	0.374	0.253	0.311	0.012	0.000	Pass
483	0.372	0.249	0.306	0.012	0.000	Pass
484	0.359	0.245	0.300	0.011	0.000	Pass
485	0.335	0.229	0.332	0.010	0.001	Pass

## 8 CONCLUSION

- a) The buckling capacity is enough to withstand the most unfavorable loads case.
- b) The erected structure is for semi-permanent use.
- c) It should be noted that if high gust wind speeds are anticipated or forecast in the locality of the tent, the temporary erected structure should be dismantled.
- d) For forecast winds in excess of 140km/hr or 38.9m/s – all fabric shall be removed from the frames, and the structure should be completely dismantled.(Please note that the locality squall or gust wind speed is affected by factors such as terrain exposure and site elevations.)
- e) The structure may only be erected in regions with wind classifications no greater than the limits specified on the attached wind analysis.
- f) The wind classifications are based upon the regional wind terrain category, topographical location and site shielding from adjacent structures. Please note that in many instances topographical factors such as a location on the crest of a hill or on top of an escarpment may yield a higher wind speed classification than that derived for a higher wind terrain category in a level topographical region.
- g) The structures in no circumstances shall ever be erected in tropical or severe tropical cyclonic condition.
- h) The structure should be fixed on C30 cement ground by minimum size M20\*200mm expansion bolts.
- i) The tent structures have not been designed to withstand additional snow and ice loadings such as when erected in alpine regions.
- j) For the projects, where the site conditions approach the design limits, extra consideration should be given to pullout tests of the expansion bolts and professional assessment of the appropriate wind classification for the site.